

Add A Frame

Before you get started...

INSPECT FOR DEFECTS PRIOR TO ASSEMBLY. Wedges may be either similar or different lengths. You must compare the assembly wedge lengths to the depth/length of the wedge routes in the frame corner. Assembly wedges are installed with the flat end face-up. When applying glue, it should be spread evenly so the entire cut end of each 45 degree piece is coated. Wedges must be installed before glue dries. A damp rag will clean off glue that may have gotten onto the front of the frame. Allow at least three hours to dry.

If the back of the frame profile is not level when the assembly wedges are installed, it will create a gap in the front of the frame. A door stop or washcloth placed under the corner of the two frame pieces will level the frame for installation of the assembly wedges. This is not necessary for relatively flat profiles.

step One

Locate assembly hardware attached to frame packaging. You will find glue, wedges, and mirror clips (if applicable). Match the length of assembly wedges to the depth of the routes.

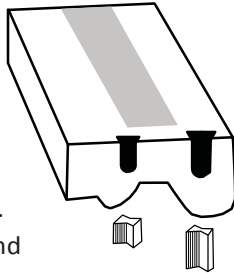

step Two

Before assembly, inspect the frame pieces for defects. Lay the four pieces face down.



step Three

Choose a corner and apply glue to both pieces. With both glued pieces face down, press glued corners together. Depending on the profile, a door stop or washcloth may be needed to level the frame.

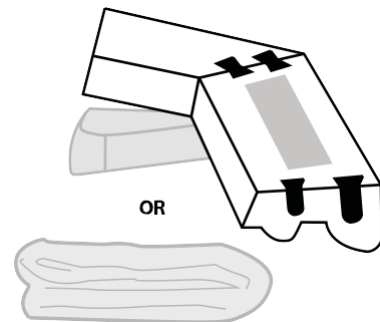
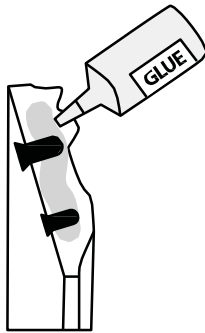

step Four

Hold the two corner pieces level and in place. Insert both assembly wedges into the correct route - so that the flat end is face-up. Tap the frame wedges flush with the back of the frame. Repeat for all corners.

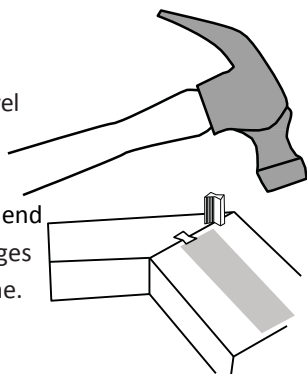

step Five

Turn over and inspect all corners. Wipe off excess glue with a damp cloth. Before the glue dries, if necessary, adjust the corners. One frame side may be higher than the other.



Add A Frame

Mirror Clip

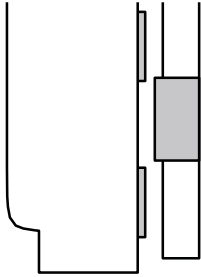

If a mirror has been installed with plastic mirror clips, replace them one at a time with flat metal offset mirror clips. Remove the double back tape from the area where the offset clips contact the back of the Add A Frame.

J-Channel

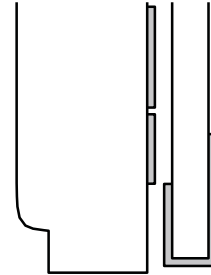

If a mirror has been installed with a j-channel at the bottom, make sure no tape comes in contact with the j-channel.

step Six >>

Test fit the Add A Frame to the mirror before removing adhesive. Check for obstacles that will affect installation, such as medicine cabinets or towel bars. As a safety measure, if the stability of the mirror is in question, place several offset metal mirror clips on the mirror into studs.

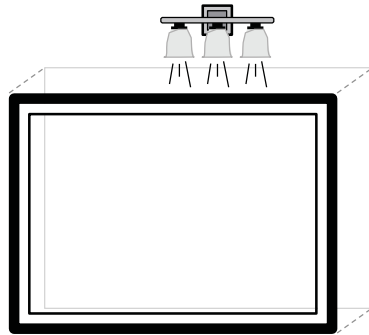

step Seven >>

Clean the mirror with a 50-50 mixture of alcohol and water.

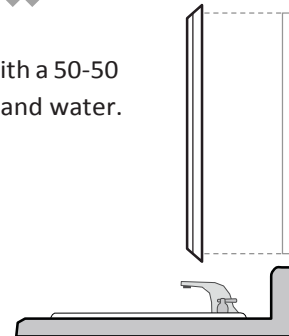

step Eight >>

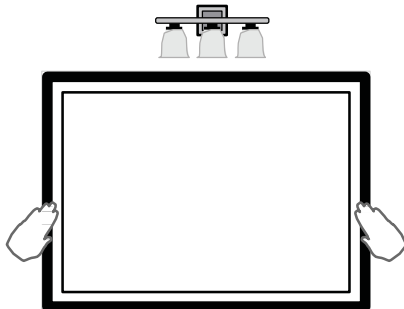

Remove the backing from the tape. Be careful not to touch to the mirror yet. Align the Add A Frame and gently press onto the mirror.

Note: If you accidentally install the frame in an undesired location, place something thin and sturdy (like fishing line) between the frame and the mirror and wiggle downwards - breaking through the adhesive.

DO NOT PULL FRAME OFF MIRROR!

Our tape is sticky! Give us a call at 800-331-6414 or email at customersupport@framemymirror.com & we can walk you through re-application.